

Spectra® IV SE Series Dome Systems

PREMIER INTEGRATED DOME SYSTEM

Product Features

- 2 Autofocus, High Resolution Integrated Camera/Optics Packages; Multiple Back Box Models
- Day/Night, 540 TVL, 128X Wide Dynamic Range (WDR), Motion Detection, Image Enhancement, and Electronic Image Stabilization (SD435 Series)
- Day/Night, 540 TVL, 128X Wide Dynamic Range (WDR), and Motion Detection (SD427 Series)
- Window Blanking
- Camera Title Overlay, 20 User-Definable Characters
- Horizontal and Zone Blanking
- On-Screen Compass and Tilt Display
- Password Protection
- Low Lux Noise Reduction
- Built-in Surge and Limited Lightning Protection

Modularity

Spectra® IV SE was designed with ease of installation and ease of maintenance in mind. Each dome system consists of three components: a back box, a dome drive, and a lower dome. These three system components are interchangeable with other Spectra IV SE dome systems, making retrofitting and application adjustments simple. Also, dome drives and lower domes can be removed and replaced reducing maintenance time.

Back Box

Spectra IV SE back box options include the following models: environmental in-ceiling (ideal for outdoor soffits), indoor in-ceiling, indoor surface mount, and standard and environmental pendant. The Spectra IV SE Series can also be ordered with heavy-duty, pressurized, and stainless steel back box options (refer to the appropriate product specification sheets for more information). Each back box model features built-in **back box memory** to store camera and location-specific dome settings, including labels, presets, patterns, and zones. A **passive UTP circuit** is located on the door assembly for convenient video transmission through twisted pair wire. For added flexibility, Pelco fiber modules can also be attached to the door assembly for transmission over single-mode or multimode fiber.

Dome Drive

The Spectra IV SE dome drive's unique **integrated optics package** incorporates many advanced features that allow the system to produce high quality video in the most difficult environments. All cameras in Spectra IV SE dome drives feature **LowLight™** technology allowing the cameras to compensate for scenes where minimal light is present. Both the 27X and the 35X cameras feature built-in motion detection and advanced **128X WDR** that enables the system to compensate for scenes where dramatic contrasts in lighting are present. The 35X day/night camera **electronic image stabilization** digitally reduces blurring of the camera image due to vibration caused by external sources, such as wind and traffic.



**SURFACE MOUNT MODEL
SD435-SMW-0**



**PENDANT MODEL
SD427-PG-0**

- Sure Focus
- Integrated Passive Unshielded Twisted Pair (UTP) Circuit
- Internal Scheduling Clock
- Ability to Add IP Network Capability by Purchasing Optional TXB-IP Module

Lower Dome

Special consideration was taken when designing the Spectra IV SE lower dome bubble to ensure that an optimal optical relationship between the lens and bubble was achieved, providing crystal clear video at long focal lengths.

Dome Systems

Spectra IV SE dome systems feature many software enhancements that increase performance and make configuration and operation easy. An **internal scheduling clock** allows for the scheduling of presets and patterns. **Window blanking** enables a user to configure up to eight, four-sided, user-defined privacy areas. **Password protection** prevents unauthorized users from changing the system settings. Configurable **on-screen compass and tilt display** provides positioning information when needed. Intuitive multilingual on-screen menus can be displayed in English, Spanish, Portuguese, Italian, French, German, Russian, Polish, Turkish, and Czech.

Spectra IV SE's variable speed capabilities range from a smooth, fast pan motion of 400 degrees per second to a smooth "creep" speed of 0.1 degree per second. The system is capable of continuous 360 degrees rotation and has an **"auto flip"** feature that allows the dome to rotate 180 degrees and reposition itself for uninterrupted viewing of any subject that passes directly beneath the dome.

In addition, with the optional Pelco TXB-IP module, you can add IP network capability at any time to a Spectra IV dome system without losing analog viewing and control. By snapping the TXB-IP module into the back box, you can stream network video to a Web browser, Endura®, Digital Sentry®, or third-party software recording solution allowing integration into virtually any IP-based system.



TECHNICAL SPECIFICATIONS

CAMERA/OPTICS

	Day/Night (35X)	Day/Night (27X)
Signal Format	NTSC (DD4CBW35) PAL (DD4CBW35-X)	NTSC (DD427) PAL (DD427-X)
Scanning System	2:1 Interlace	2:1 Interlace
Image Sensor	1/4-inch EXview HAD™	1/4-inch EXview HAD
Effective Pixels		
NTSC	768 (H) X 494 (V)	768 (H) X 494 (V)
PAL	752 (H) X 582 (V)	752 (H) X 582 (V)
Horizontal Resolution		
NTSC	>540 TV Lines	>540 TV Lines
PAL	>540 TV Lines	>540 TV Lines
Lens	f/1.4 (focal length, 3.4 ~ 119 mm)	f/1.4 (focal length, 3.4 ~ 91.8 mm)
Zoom	35X optical, 12X digital	27X optical, 12X digital
Zoom Speed (optical range)	3.2/4.6/6.6 seconds	3.2/4.6/6.6 seconds
Horizontal Angle of view	55.8° at 3.4 mm wide zoom; 1.7° at 119 mm telephoto zoom	55.8° at 3.4 mm wide zoom; 2.3° at 91.8 mm telephoto zoom
Focus	Automatic with manual override	Automatic with manual override
Maximum Sensitivity at 35 IRE		
NTSC/EIA	0.55 lux at 1/60 sec (color) 0.018 lux at 1/2 sec (color) 0.00018 lux at 1/2 sec (B-W)	0.55 lux at 1/60 sec (color) 0.018 lux at 1/2 sec (color) 0.00018 lux at 1/2 sec (B-W)
PAL/CCIR	0.45 lux at 1/50 sec (color) 0.015 lux at 1/1.5 sec (color) 0.00015 lux at 1/1.5 sec (B-W)	0.45 lux at 1/50 sec (color) 0.015 lux at 1/1.5 sec (color) 0.00015 lux at 1/1.5 sec (B-W)
Sync System	Internal/AC line lock, phase adjustable using remote control, V-Sync	Internal/AC line lock, phase adjustable using remote control, V-Sync
White Balance	Automatic with manual override	Automatic with manual override
Shutter Speed	Automatic (electronic iris)/Manual	Automatic (electronic iris)/Manual
NTSC	1/2 ~ 1/30,000	1/2 ~ 1/30,000
PAL	1/1.5 ~ 1/30,000	1/1.5 ~ 1/30,000
Iris Control	Automatic iris control with manual override	Automatic iris control with manual override
Gain Control	Automatic/OFF	Automatic/OFF
Video Output	1 Vp-p, 75 ohms	1 Vp-p, 75 ohms
Video Signal-to-Noise	>50 dB	>50 dB
Wide Dynamic Range	128X	128X
Electronic Image Stabilization	Integrated/Selectable	—
Image Enhancement	Integrated/Selectable	—

TECHNICAL SPECIFICATIONS

DOMES DRIVE FEATURES

- 256 Presets
- $\pm 0.1^\circ$ Preset Accuracy
- Electronic Image Stabilization (35X model)
- Image Enhancement (35X model)
- Multilingual Menus (English, Spanish, Portuguese, Italian, French, German, Russian, Polish, Turkish, and Czech)
- RJ-45 Data Port for Software Update and Setup
- On-Screen Compass, Tilt, and Zoom Display
- $400^\circ/\text{sec}$ Pan Preset Speed and $200^\circ/\text{sec}$ Tilt Preset Speed
- Rotating Discreet Liner with Sealed Fixed Bubble
- Window Blanking: Up to 8, Four-Sided, User-Defined Shapes
- 8 Zones (configurable in size) Can Be Labeled with up to 20 Characters Each or Set to Output Blank Video
- 7 Alarm Inputs
- 1 Auxiliary (Form C) Relay Output and 1 Open Collector Auxiliary Output (can be alternately configured to operate upon alarm)
- Configurable Locations of Labels and On-Screen Displays
- Action on Alarm: Alarms Can Be Individually Configured for 3 Priority Levels, to Initiate a Stored Pattern, or to Go to an Associated Preset When Received
- Resume After Alarm: Allows the Dome to Return to a Previously Configured State After Alarm Acknowledgement or to its Previous Position Before Alarm
- Multiple Park and Power-Up Action
- Patterns: Up to 8, On-Screen, User-Defined Configurable Patterns; Includes Pan, Tilt, Zoom, and Preset Functions
- Proportional Pan/Tilt: Continually Decreases Pan/Tilt Speeds in Proportion to Depth of Zoom
- Variable Scan Speed: Scan Speed Can Be Configurable Between 1 to $40^\circ/\text{sec}$
- Pan Motion Allows 0.1 to $150^\circ/\text{sec}$ Pan Speed
- Configurable Limit Stops for Auto/Random/Frame Scan Modes
- Autosensing Protocol (Coaxitron®, RS-422 Pelco P and Pelco D, Sensormatic®, Vicon®); Accepts Other Control Protocols with Optional Translator Card
- Digital Position and Zoom Control and Feedback through Pelco D Protocol
- Built-in Menu System for Setup of Configurable Functions
- "Auto Flip" Rotates Dome 180° at Bottom of Tilt Travel
- Configurable Zoom Speeds
- Low Lux Noise Reduction (reduces noise in low light)

WINDOW BLANKING

Window blanking allows a user to configure up to eight, four-sided, user-defined areas that cannot be viewed by the operator of the dome system. A blanked area will move with pan and tilt functions and automatically adjust in size as the lens zooms telephoto and wide.



BEFORE



AFTER

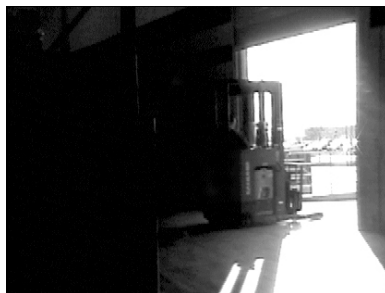

BEFORE



AFTER

WIDE DYNAMIC RANGE

The WDR setting balances the brightest and darkest sections of a scene to produce a picture that provides more detail.

TECHNICAL SPECIFICATIONS

BACK BOX FEATURES

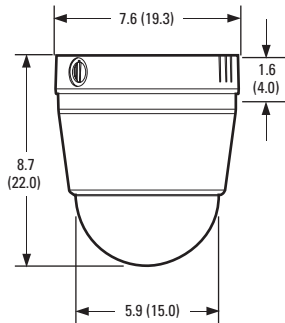

Surface Mount (Indoor)

- Built-in Memory Stores Camera/Dome Settings
- Available in Black or White Finish
- Quick Disconnect to Dome Drive
- Injection-Molded Plastic
- Integrated Passive UTP

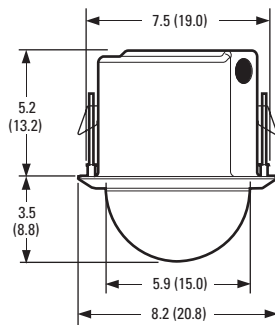

In-Ceiling (Indoor)

- Built-in Memory Stores Camera/Dome Settings
- Single Back Box for Suspended or Hard Ceiling Applications
- Requires 5.25-Inch Space Above Ceiling and 3.25 Inches Below
- Minimum Ceiling Thickness 0.5-Inch; Maximum 1.75 Inches
- Quick Disconnect to Dome Drive
- Aluminum Construction
- Suitable for Use in Environmental Air Handling Spaces
- Integrated Passive UTP

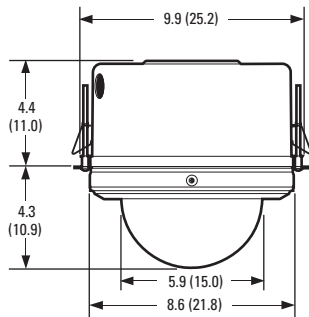

Environmental In-Ceiling

- Built-in Memory Stores Camera/Dome Settings
- Single Back Box for Hard Ceiling Applications
- Requires 4.4-Inch Space Above Ceiling and 4.3 Inches Below
- Includes Heater and Fan
- Minimum Ceiling Thickness 0.5-Inch; Maximum 1.75 Inches
- Quick Disconnect to Dome Drive
- Aluminum Construction
- Integrated Passive UTP



(ENVIRONMENTAL DOME WITH SUN SHROUD SHOWN)

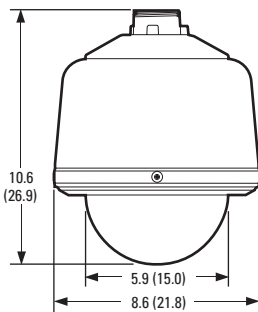

Standard and Environmental Pendant

- Standard and Environmental Models
- Built-in Memory Stores Camera/Dome Settings
- Standard Pendant Available in Black or Gray Finish; Environmental Pendant Gray Finish Only
- Quick Disconnect to Dome Drive
- Aluminum Construction
- Environmental Model Includes Sun Shield, Fan, and Heater
- Integrated Passive UTP

NOTE: VALUES IN PARENTHESES ARE CENTIMETERS; ALL OTHERS ARE INCHES.

Note: The Spectra IV SE Series can be ordered with heavy-duty, pressurized, and stainless steel back box options. Refer to the appropriate product specification sheets for more information.

TECHNICAL SPECIFICATIONS

MECHANICAL *(Dome Drive Only)*

Pan Movement	360° continuous pan rotation
Vertical Tilt	Unobstructed +2° to -92°
Manual Pan/Tilt Speeds	
Pan	0.1° to 80°/sec manual operation, 150°/sec Turbo
Tilt	0.1° to 40°/sec manual operation
Preset Speeds	
Pan	400°/sec
Tilt	200°/sec
	For variable-speed operation, an appropriate controller is required (with nonvariable speed control, Spectra IV SE pan/tilt speed is 20°/sec)

ELECTRICAL

Input Voltage	18 to 32 VAC; 24 VAC nominal 22 to 27 VDC; 24 VDC nominal
Input Power	
24 VAC	23 VA nominal (without heater); 73 VA nominal (with heater)
24 VDC	0.7 A nominal (without heater); 3 A nominal (with heater)
Fuse	1.25 A
Auxiliary Outputs	2
Alarm Inputs	7

CERTIFICATIONS/RATINGS/PATENTS

- CE, Class B
- FCC, Class B
- UL/cUL Listed
- C-Tick
- S Mark for Argentina
- Meets NEMA Type 4X, IP66 when installed properly (BB4-F-E, BB4-PB, BB4-PG, and BB4-PG-E)
- Meets NEMA Type 1, IP40 (BB4-SMW, BB4-SMB, and BB4-F)
- U.S. Patents 5,931,432; 6,793,415 B2; 6,802,656 B2; 6,821,222 B2; 7,161,615 B2

GENERAL

Construction		
Back Box		
Surface Mount	Plastic	
In-Ceiling	Aluminum	
Pendant	Aluminum	
Dome Drive	Aluminum, thermo plastic	
Bubble	Acrylic	
Light Attenuation		
Smoked	f/0.5 light loss	
Clear	Zero light loss	
Chrome	f/2.0 light loss	
Gold	f/2.0 light loss	
Cable Entry (Back Box)		
In-Ceiling and	0.75-inch conduit fitting	
Surface Mount	Through 1.5-inch NPT pendant mount	
Pendant		
Weight (approximate)	<u>Unit</u>	<u>Shipping</u>
Back Box		
Surface Mount	0.7 lb (0.32 kg)	2 lb (0.90 kg)
In-Ceiling	1.5 lb (0.68 kg)	2 lb (0.90 kg)
Environmental		
In-Ceiling	2.1 lb (0.95 kg)	3 lb (1.36 kg)
Standard Pendant	2.4 lb (1.09 kg)	4 lb (1.81 kg)
Environmental Pendant	3.5 lb (1.59 kg)	5 lb (2.27 kg)
Dome Drive	3.3 lb (1.48 kg)	5 lb (2.27 kg)
Lower Dome		
Surface Mount	0.4 lb (0.18 kg)	1 lb (0.45 kg)
In-Ceiling	0.2 lb (0.09 kg)	1 lb (0.45 kg)
Pendant and		
Environmental		
In-Ceiling	0.6 lb (0.27 kg)	2 lb (0.90 kg)
Environment		
Surface Mount	Indoor	
In-Ceiling	Indoor	
Environmental In-Ceiling	Outdoor	
Pendant, Standard		
and Environmental	Indoor/outdoor	
Operating Temperature		
Surface Mount and		
Indoor In-Ceiling	32° to 122°F (0° to 50°C)	
Standard Pendant	(Assumes no wind chill factor)	
Maximum	113°F (45°C) absolute maximum; 95°F (35°C) sustained maximum	
Minimum	25°F (-4°C) sustained minimum	
Environmental In-Ceiling		
and		
Environmental Pendant	(Assumes no wind chill factor)	
Maximum	140°F (60°C) absolute maximum; 122°F (50°C) sustained maximum	
Minimum	-60°F (-51°C) absolute minimum; prevents icing at sustained minimum of -50°F (-45°C); de-ices 0.1 inch (2.5 mm) within 3 hours after power-up	
TS2	-29.2° to 165°F (-34° to 74°C)	
	<i>Per NEMA TS2, para. 2.1.5.1, using fig. 2.1 test profile</i>	
Effective Projected		
Area (EPA)	20.5 square inches (without mount)	47 square inches (with IWM Series mount)

RELATED PRODUCTS

OPTIONAL ACCESSORIES

- DD5-FM** Fixed camera mount adapter. Interchangeable with all Spectra IV dome drives.
- IPS-RMK** Remote monitor kit. Stand-alone kit consisting of a 5.6-inch TFT-LCD monitor, Palm™ OS compatible handheld, cables and carrying case. Allows viewing of camera video, local PTZ control, system setup, and system software upgrades at any installed dome.
- IPS-CABLE** Remote monitor cable and software kit consisting of the Spectra IV remote monitor interface cable and necessary software for use with a PC (Windows® 95, Windows 98, Windows Me, Windows 2000), Palm OS compatible handheld or iPaq™ Series Pocket PC. Refer to www.pelco.com for a list of compatible devices.
- IPS-RDPE-2*** Remote data port. 24 VAC, wall/pole mount video/data breakout box. Allows ground-level control/configuration and Spectra IV OS software upgrades when used with the IPS-RMK or IPS-CABLE.
- TXB Series*** Translator boards for AD™ Manchester, Hervis, Bosch® (Philips, Burle), TASS, and NTCIP protocols.
- TXB-IP Series*** Communication module that allows you to control and monitor Spectra IV dome systems over an IP network (in-ceiling and pendant models only).
- FS85011A*** Fiber transmitter sends 1 unidirectional composite video channel and 1 bidirectional data channel over 1 multimode or single-mode fiber optical cable.

*If TXB or FS85011A boards are installed, remote upload of system software will not be possible.

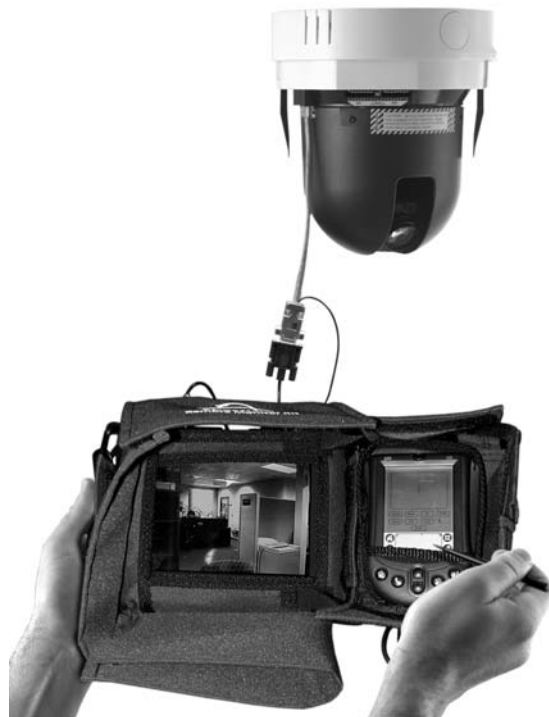

IPS-RMK REMOTE MONITOR KIT

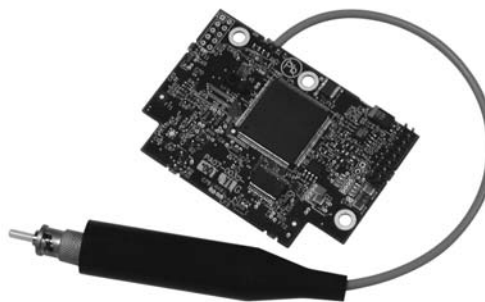

FS85011A FIBER MODULE

RELATED PRODUCTS

RECOMMENDED MOUNTS

Surface Mount Domes

PASMB	Pendant adapter for surface mount dome, black
SD53SM-P	2' x 2' drop ceiling panel for BB4-SMW and BB4T-SMW series back boxes; replaces 2' x 2' ceiling tile; aluminum construction

In-Ceiling Domes

SD5-P	2' x 2' drop ceiling panel, aluminum construction; replaces 2' x 2' ceiling tile
SCA1	Support rails for BB4-F; for use in ceiling tile applications

Pendant Domes

BB5-PCA-BK*	Pendant conduit adapter, black
BB5-PCA-GY*	Pendant conduit adapter, gray
IWM Series	Wall mount, with or without integral 24 VAC, 100 VA transformer; black or gray finish; can be adapted for corner, parapet, or pole applications
MRCA	Ceiling mount, black
PP4348	Parapet roof mount
PP350/PP351	Parapet wall/roof mount
SWM Series	Compact wall mount, black or gray finish; can be adapted for corner or pole applications

*Not suitable for use with heavy-duty, pressurized, or stainless steel Spectra domes.

RECOMMENDED POWER SUPPLIES

MCS Series	Indoor, 24 VAC power supply
WCS Series	Outdoor, 24 VAC power supply

Refer to individual power supply specifications for more information.

SYSTEM AND COMPONENT MODELS

SYSTEM MODEL NUMBERS

Type	Back Box Color	Lower Dome	35X Day/Night*	27X Day/Night*
Surface Mount	White	Smoked	SD435-SMW-0	SD427-SMW-0
		Clear	SD435-SMW-1	SD427-SMW-1
		Chrome	SD435-SMW-2	SD427-SMW-2
		Gold	SD435-SMW-3	SD427-SMW-3
	Black	Smoked	SD435-SMB-0	SD427-SMB-0
		Clear	SD435-SMB-1	SD427-SMB-1
		Chrome	SD435-SMB-2	SD427-SMB-2
		Gold	SD435-SMB-3	SD427-SMB-3
In-Ceiling, Indoor	Black	Smoked	SD435-F0	SD427-F0
		Clear	SD435-F1	SD427-F1
		Chrome	SD435-F2	SD427-F2
		Gold	SD435-F3	SD427-F3
In-Ceiling, Environmental ¹	Black	Smoked	SD435-F-E0	SD427-F-E0
		Clear	SD435-F-E1	SD427-F-E1
Pendant, Standard	Black	Smoked	SD435-PB-0	SD427-PB-0
		Clear	SD435-PB-1	SD427-PB-1
		Chrome	SD435-PB-2	SD427-PB-2
		Gold	SD435-PB-3	SD427-PB-3
	Lt. Gray	Smoked	SD435-PG-0	SD427-PG-0
		Clear	SD435-PG-1	SD427-PG-1
		Chrome	SD435-PG-2	SD427-PG-2
		Gold	SD435-PG-3	SD427-PG-3
Pendant, Environmental ¹	Lt. Gray	Smoked	SD435-PG-E0	SD427-PG-E0
		Clear	SD435-PG-E1	SD427-PG-E1

COMPONENT MODEL NUMBERS

Back Box	Dome Drive*	Lower Dome [†]
BB4-SMB Surface mount, black BB4-SMW Surface mount, white BB4-F In-ceiling, black BB4-F-E In-ceiling, black, environmental BB4-PB Pendant mount, black, standard BB4-PG Pendant mount, gray, standard BB4-PG-E Pendant mount, gray, environmental	DD427 Day/Night (NTSC) camera (27X) DD4CBW35 Day/Night (NTSC) camera (35X) DD5-FM Removable, fixed mount bracket only (camera and lens not included). Interchangeable with all Spectra IV dome drives.	LD53SMB-0 Smoked, surface, black LD53SMB-1 Clear, surface, black LD53SMB-2 Chrome, surface, black LD53SMB-3 Gold, surface, black LD53SMW-0 Smoked, surface, white LD53SMW-1 Clear, surface, white LD53SMW-2 Chrome, surface, white LD53SMW-3 Gold, surface, white LD5F-0 Smoked, in-ceiling LD5F-1 Clear, in-ceiling LD5F-2 Chrome, in-ceiling LD5F-3 Gold, in-ceiling LD53PB-0 Smoked, pendant, black LD53PB-1 Clear, pendant, black LD53PB-2 Chrome, pendant, black [§] LD53PB-3 Gold, pendant, black [§]
Notes: To order a fixed mount dome system, refer to the component models above and select one each of the following options: back box (BB4-F), dome drive (DD5-FM), plus choice of lower dome (LD5F-0, LD5F-1, LD5F-2, or LD5F-3). For environmental applications, you must order an environmental back box (BB4-F-E) or (BB4-PG-E). DD5-FM is ideal for use with Pelco's C10DN-6, C10DN-6X, C10CH-6, C10CH-6X, CCC1390H-6, and CCC1390H-6X cameras with selected Pelco lenses.		

*For PAL and CCIR models add "-X" suffix to part number (for example, SD435-SMW-0-X).

¹Environmental dome systems include a heater, fan, and the environmental pendant also includes a sun shield.

[†]Use the pendant lower domes with the environmental in-ceiling and environmental pendant back boxes.

[§]Not recommended for outdoor use due to possible light reflections.

Pelco, Inc. Worldwide Headquarters:

3500 Pelco Way, Clovis, California 93612-5699 USA

USA & Canada Tel (800) 289-9100 • FAX (800) 289-9150

International Tel +1 (559) 292-1981 • FAX +1 (559) 348-1120

www.pelco.com

Pelco, the Pelco logo, Coaxitron, Digital Sentry, Endura, and Spectra are registered trademarks of Pelco, Inc. LowLight is a trademark of Pelco, Inc.

All product names and services identified throughout this document are trademarks or registered trademarks of their respective companies. The absence of a trademark or registered trademark from this document does not constitute a waiver of intellectual property rights.

Product specifications and availability subject to change without notice.

©Copyright 2010, Pelco, Inc. All rights reserved.